

Item # _____

Project _____

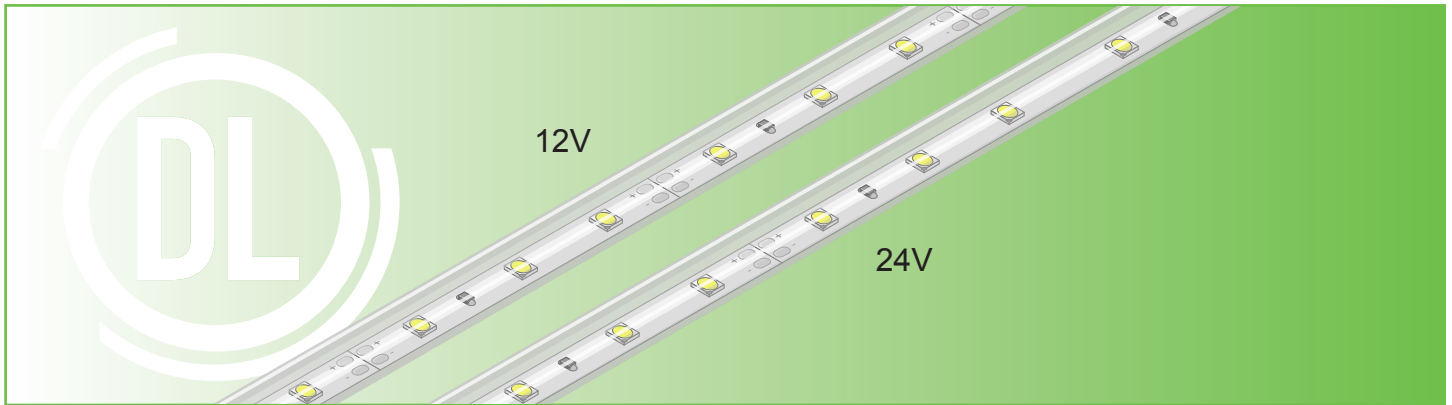

		DI-12V-BLBSC1	DI-24V-BLBSC1
Voltage		12V	24V
Wattage		1.46/ft.	1.46/ft.
Lumens	2700K	107/ft.	106/ft.
	3000K	116/ft.	114/ft.
	5000K	116/ft.	114/ft.
Max. Run¹		27 ft.	55 ft.
Cut Points		2 in.	4 in.
LED Chips		18/ft	
Color Temperature		2700K, 3000K, 5000K	
CRI		90+	
Dimmable		Yes	
Dimensions		0.39 x 0.18 in. (W x H)	
Environment²		Indoor / Wet Location	
Certification		UL Listed 2108	
Warranty		7-Year Warranty	

SKU Builder

DI	-	<input type="text"/>	-	BLBSC	-	<input type="text"/>	-	<input type="text"/>
		Voltage		Model		Type		Color Temp
		<input type="text" value="12V"/>				<input type="text" value="1"/>		<input type="text" value="27"/>
		<input type="text" value="24V"/>						<input type="text" value="30"/>
								<input type="text" value="50"/>
								<input type="text" value="W016"/>
								<input type="text" value="W100"/>

Example: DI-12V-BLBSC1-27-W016 = Diode LED, 12 Volt, Wet Location BLAZE™ BASICS, Type 1, 2,700° CCT, 16.4 foot spool.

BLAZE™ BASICS 100 Wet Location LED Tape Light

SPECIFICATION SHEET

SPECIFICATIONS

- LED Chip Type: 2835 GuangMu Chip
- LED Chip Beam Angle: 120°
- Luminous Efficacy³ (lm/w): 72~79
- Mounting⁴: Mounting Clips & 3M 55236 Adhesive Backing
- Connections⁵: 2.5 inch hard-wire lead: 20/2 AWG
- Ambient Temp⁶: -4 ~ 122°F (-20 ~ 50°C)
- Operating Temp⁷: -4 ~ 176°F (-20 ~ 80°C)

COMPLIANCE & REGULATORY APPROVALS

Safety

- UL Listed 2108 Low Voltage Lighting System / Low Voltage Luminaire. UL 1598 / CSA 250.0-08, UL 8750. UL 879 / CAN/CSA-C22.2 no. 207-M89. Certified for United States and Canada. File # E469769.
- UL Listed Field Cuttable.
- UL Recognized Component - Sign Accessories. Available in UL Sign Components Manual (SAMS Manual). File # E469770.
- CE & EMC Compliant: Verification No. GZEM141200683705V

Environmental

- RoHS Compliant: Verification No. CANEC1610091501

Performance

- Can be used to comply with TITLE 24 Part 6 High efficacy LED requirements - JA8-2016-E
- LED chip data measured in accordance to IES LM-80-08.
- Photometric & Colorimetry data measured in accordance to IES LM-79-08, in Elemental LED's Innovation Lab.

COMPATIBLE DRIVERS & CONTROLS

Visit the product page at www.DiodeLED.com for compatible LED drivers & controls. See the Installation Guide for system diagrams.

ADDITIONAL ACCESSORIES

Accessories listed below fully support our Tape Light product line. Further information on these products and more accessories can be found in our latest catalog or online at www.DiodeLED.com.

MECHANICAL DIAGRAM

BLAZE™ BASICS WET LOCATION END CAP

Terminal End Cap

DI-WL-EC

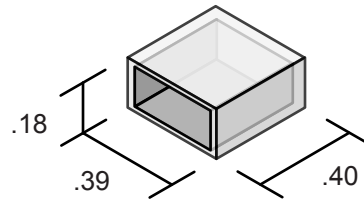

1. Each maximum run requires a dedicated power feed from the driver. Do not extend beyond the recommended maximum run length.
2. All plastics are affected by the elements and may shift in color and other properties after product installation, particularly with direct exposure to sun, chlorinated water, and other chemicals.
3. Actual efficacy value is dependent to specified LED driver (power supply). An estimated efficacy value can be calculated as follows: Lumen value divided by average power consumption per foot.
4. Ideal tape application temperature range is 70°F to 100°F (21°C to 38°C). Initial tape application to surfaces at temperatures below 50°F (10°C) is not recommended because the adhesive becomes too firm to adhere readily. However, once properly applied, low temperature holding is generally satisfactory.
5. Wire leads and accessories are not rated for in-wall installation unless otherwise noted. Attached wire leads and connections are field-cuttable.
6. Do not install product in an environment outside the listed ambient temperature. Exceeding the maximum ambient temperature may damage LED chips, reduce the total lamp life, lumen output, and/or adversely impact color consistency.
7. Operating temperature is measured according to the minimum and maximum ambient temperature environment.

BLAZE™ BASICS 100 Wet Location LED Tape Light

SPECIFICATION SHEET

MECHANICAL DIAGRAM

BLAZE™ BASICS 100 Wet Location 12V

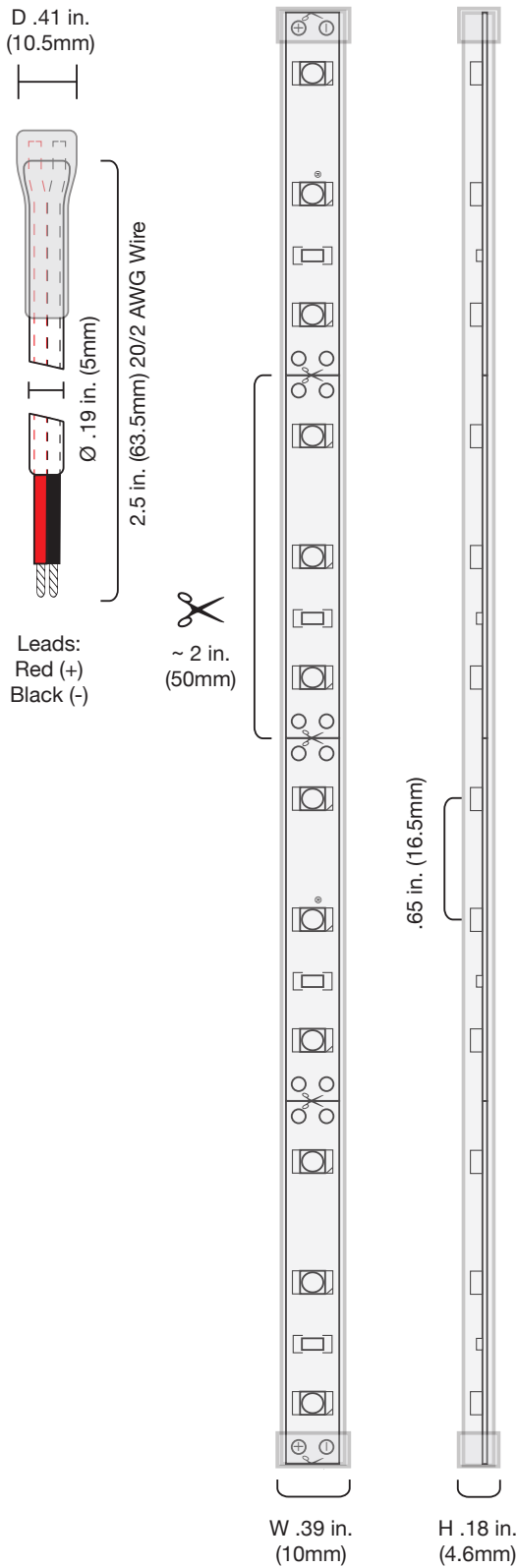

BLAZE™ BASICS 100 Wet Location 24V

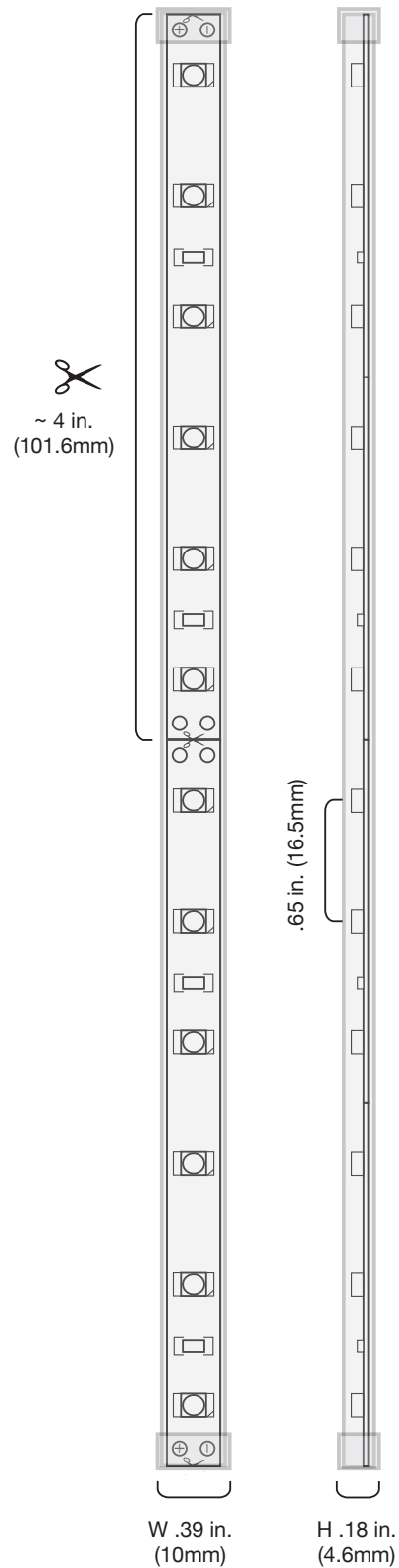

BLAZE™ BASICS 100 Wet Location LED Tape Light

SPECIFICATION SHEET

PHOTOMETRICS

BLAZE™ BASICS DI-12V-BLBSC1

DI-12V-BLBSC1-27

DI-12V-BLBSC1-30

DI-12V-BLBSC1-50

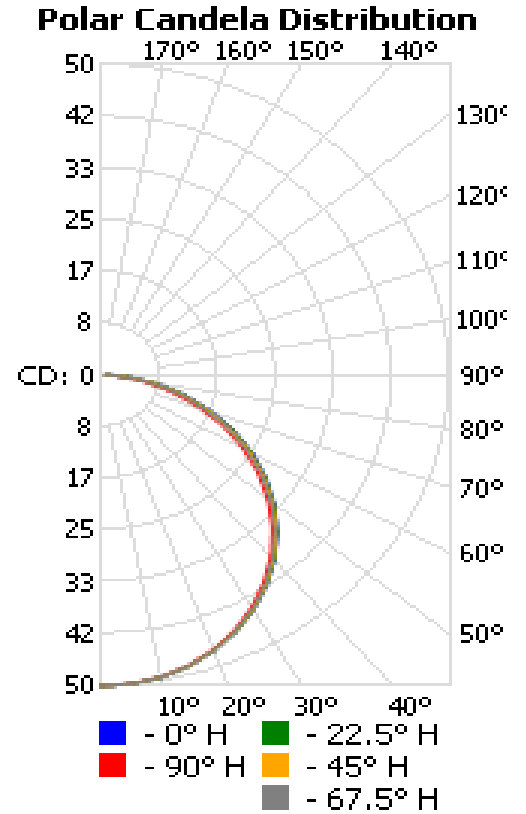
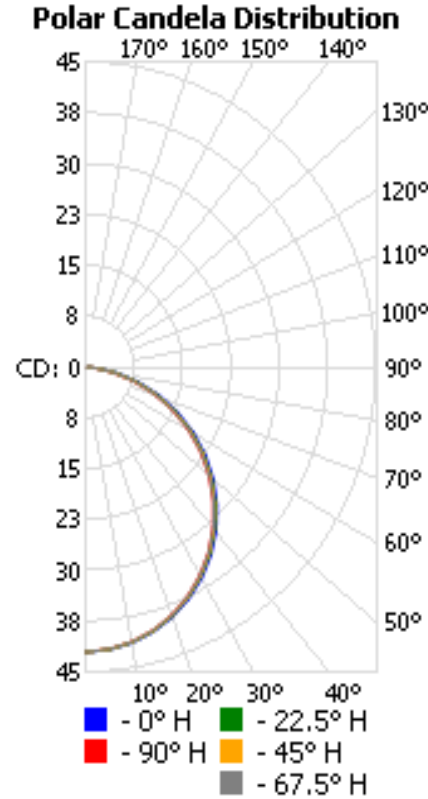
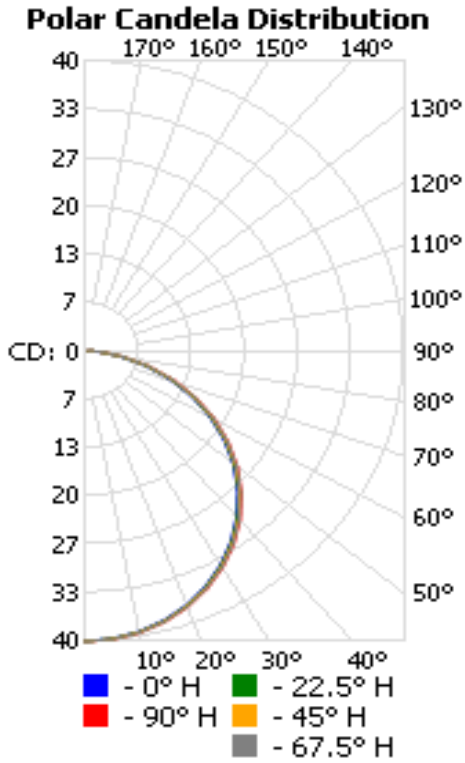

BLAZE™ BASICS 100 Wet Location LED Tape Light

SPECIFICATION SHEET

PHOTOMETRICS

BLAZE™ BASICS DI-24V-BLBSC1

DI-24V-BLBSC1-27

DI-24V-BLBSC1-30

DI-24V-BLBSC1-50

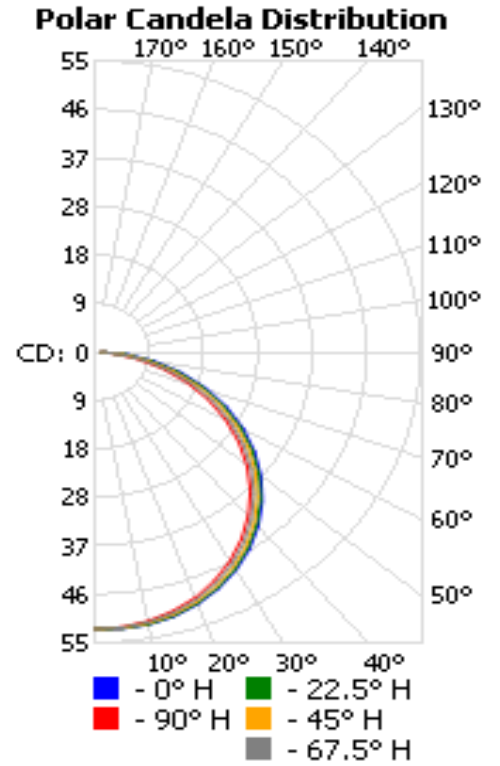
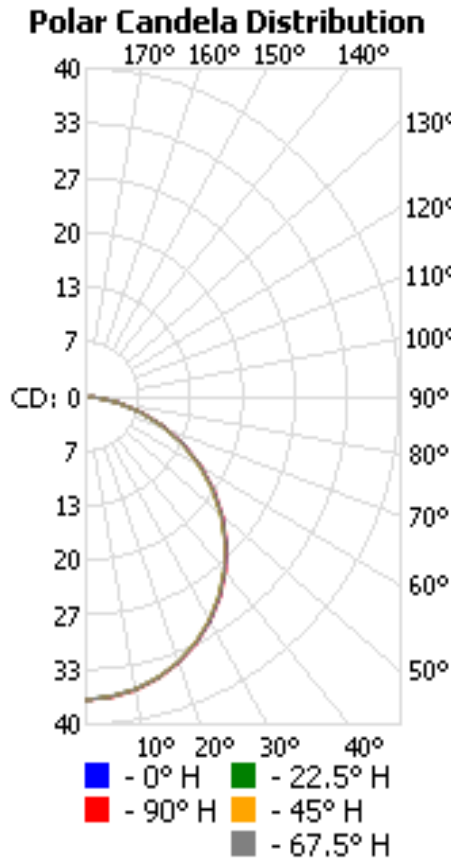
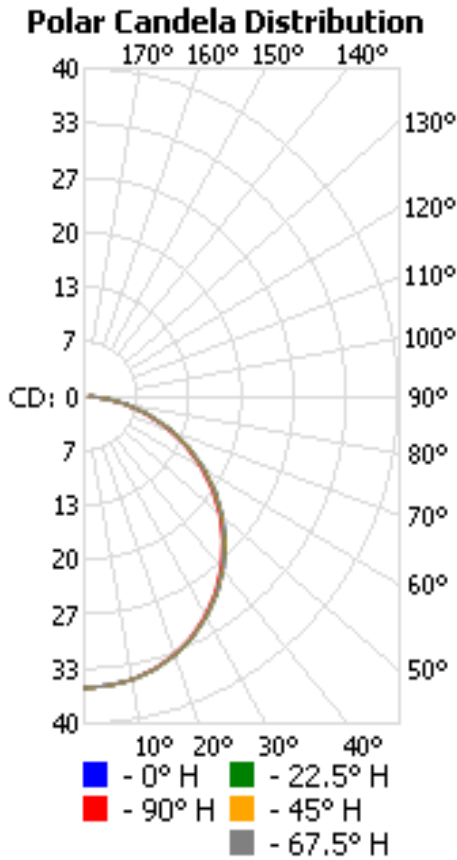

BLAZE™ BASICS 100 Wet Location LED Tape Light

SPECIFICATION SHEET

LED DRIVERS (Required)

The following Listed LED Drivers are recommended to meet NEC code when installed according to specifications. For additional LED Driver options see Diode LED's product page at: <https://www.diodeled.com/products/led-power-supplies.html>

SWITCHEX® DRIVER + DIMMER SWITCH

SWITCHEX combines an LED driver and LED dimmer switch into a single integrated unit. Fits into standard switch boxes.

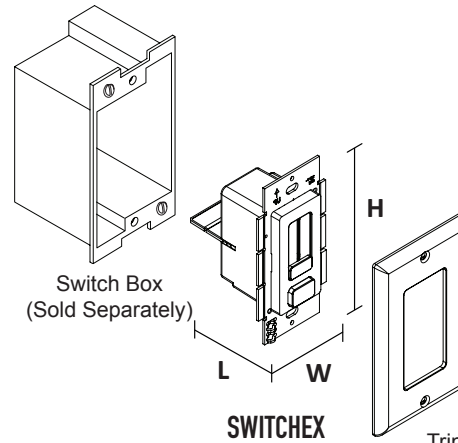
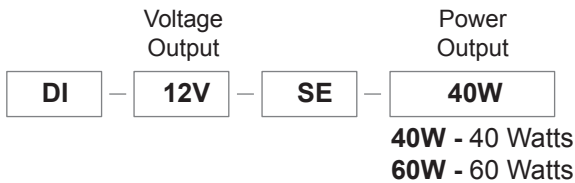

SKU	L - LENGTH	W - WIDTH	H - HEIGHT
DI-12V-SE-40W			
DI-12V-SE-60W			

Fits in Standard Switch Box



LO-PRO® JUNCTION BOX & DRIVER COMBO - 12V CONSTANT VOLTAGE LED DRIVER

Use Constant Voltage Drivers to power your low voltage tape light. Compatible with Standard 120VAC On/Off Switches, REIGN® 12-24V Low Voltage Dimmers, TOUCHDIAL™ Control System, DMX Decoders, and PWM Controls.

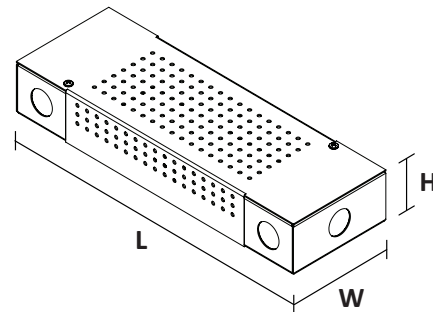
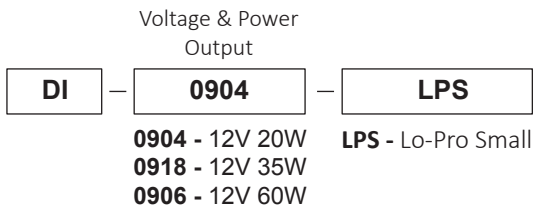

SKU	L - LENGTH	W - WIDTH	H - HEIGHT
DI-0904-LPS			
DI-0918-LPS	11.25 in.	3.75 in.	1.90 in.
DI-0906-LPS			



LO-PRO® JUNCTION BOX & DRIVER COMBO - 12V COMMERCIAL GRADE 0-10V LED DIMMABLE DRIVER

Compatible with 0-10V controls and dimmer systems.

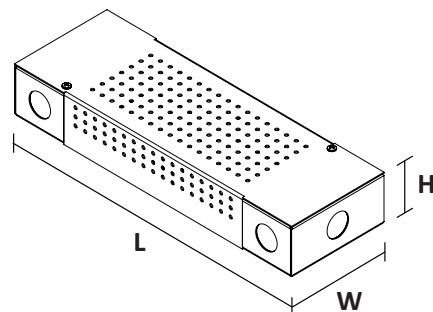
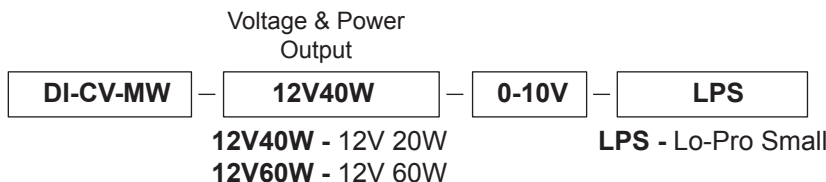

SKU	L - LENGTH	W - WIDTH	H - HEIGHT
DI-CV-MW-12V40W-0-10V-LPS			
DI-CV-MW-12V60W-0-10V-LPS	11.25 in.	3.75 in.	1.90 in.



BLAZE™ BASICS 100 Wet Location LED Tape Light

SPECIFICATION SHEET

LED DRIVERS (Required)

The following Listed LED Drivers are recommended to meet NEC code when installed according to specifications. For additional LED Driver options see Diode LED's product page at: <https://www.diodeled.com/products/led-power-supplies.html>

OMNIDRIVE® 2 ELECTRONIC DIMMABLE LED DRIVER

OMNIDRIVE 2 features a zero minimum load and 100-5% dimming range. Compatible with Forward Phase and Reverse Phase Dimmers.

Voltage & Power
Output



12V24W - 12V 24W
12V60W - 12V 60W
12V120W - 12V 120W
12V200W - 12V 200W

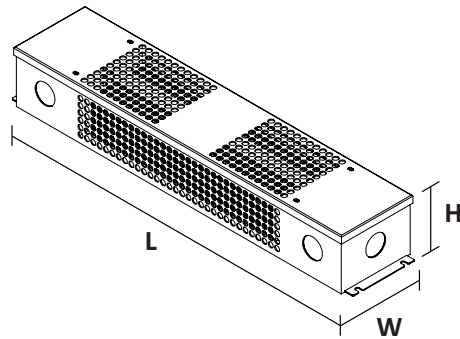

SKU	L - LENGTH	W - WIDTH	H - HEIGHT
DI-OD2-12V24W	13.75 in.	3.00 in.	1.60 in.
DI-OD2-12V60W	13.75 in.	3.00 in.	1.60 in.
DI-OD2-12V120W	15.00 in.	3.10 in.	2.40 in.
DI-OD2-12V200W	16.10 in.	3.40 in.	2.40 in.

LUTRON® Hi-lume 1% LED DIMMABLE DRIVER

Hi-lume 1% LED driver has a minimum load of 5W and Dims from 100-1%.

Voltage & Power
Output

3-Wire or 2-Wire Dimmers



12V40W - 12V 40W

L3D - Lutron Hi-lume 1% EcoSystem /3-Wire Voltage LED Driver
LTE - Lutron Hi-lume 1% 2-Wire LED Driver (120V Forward Phase Only)

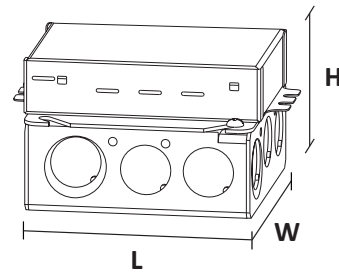

SKU	L - LENGTH	W - WIDTH	H - HEIGHT
DI-DM-12V40W-L3D	4.89 in.	4.00 in.	2.62 in.
DDI-DM-12V40W-LTE			

LUTRON® Hi-lume Premier 0.1% LED DIMMABLE DRIVER

Hi-Lume Premier 0.1% LED driver has a minimum load of 5W and Dims from 100-0.1%.

Voltage & Power
Output

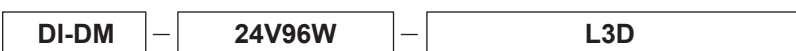

12V40W - 12V 40W

L3D - Lutron Hi-lume Premier 0.1% EcoSystem/3-Wire LED Driver

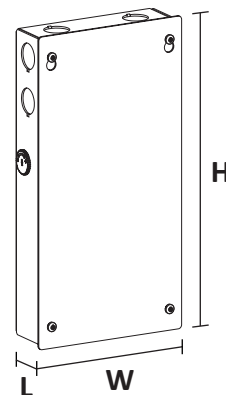

SKU	L - LENGTH	W - WIDTH	H - HEIGHT
DI-DM-24V96W-L3D	5.50 in.	2.20 in.	10.50 in.

BLAZE™ BASICS 100 Wet Location LED Tape Light

SPECIFICATION SHEET

LED DRIVERS (Required)

The following Listed LED Drivers are recommended for compatibility and to meet NEC code when installed according to specifications. For additional LED Driver options see Diode LED's product page at: <https://www.diodeled.com/products/led-power-supplies.html>

SWITCHEX® DRIVER + DIMMER SWITCH

SWITCHEX combines an LED driver and LED dimmer switch into a single integrated unit. Fits into standard switch boxes.



SKU	L - LENGTH	W - WIDTH	H - HEIGHT
DI-24V-SE-60W	1.40 in.	2.10 in.	4.10 in.
DI-24V-SE-100W	1.40 in.	2.10 in.	4.10 in.

Fits in Standard Switch Box

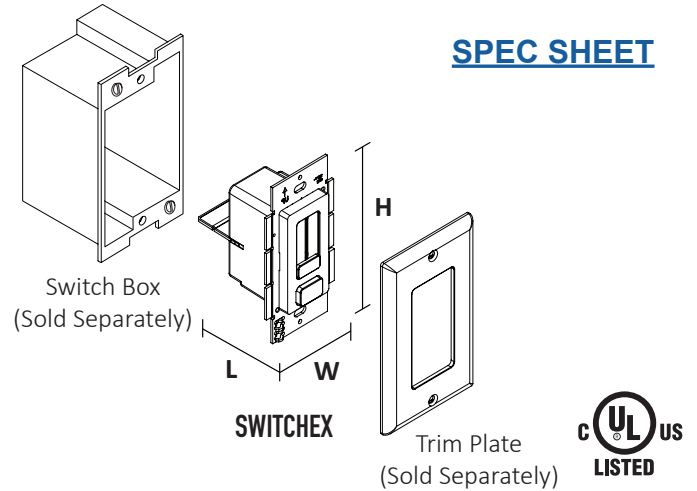

LO-PRO® JUNCTION BOX & DRIVER COMBO - 24V CONSTANT VOLTAGE LED DRIVER

Use Constant Voltage Drivers to power your lighting system. Compatible with Standard 120VAC On/Off Switches, REIGN® Low Voltage Dimmers, TOUCHDIAL™ Control System, DMX Decoders, and PWM Controls.

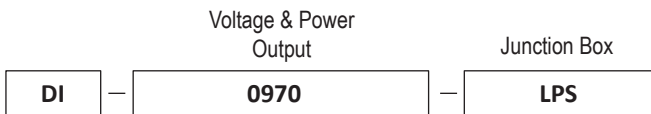

SKU	L - LENGTH	W - WIDTH	H - HEIGHT
DI-0970-LPS	11.25 in.	3.75 in.	1.90 in.
DI-CV-MW24V60W-277-LPS	11.25 in.	3.75 in.	1.90 in.
DI-CV-MW24V90W-277-LPS	11.25 in.	3.75 in.	1.90 in.
DI-0954-LPL	13.5 in.	4.5 in.	2.37 in.

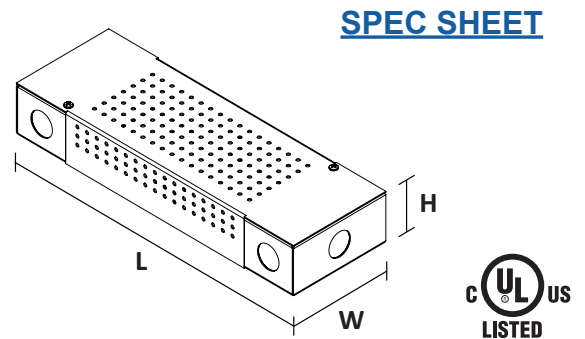

LO-PRO® JUNCTION BOX & DRIVER COMBO - 24V COMMERCIAL GRADE 0-10V LED DIMMABLE DRIVER

Compatible with 0-10V controls and dimming systems.

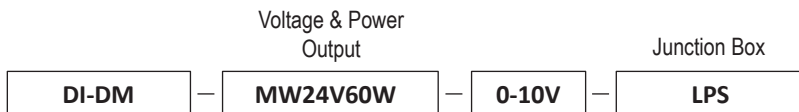

SKU	L - LENGTH	W - WIDTH	H - HEIGHT
DI-DM-MW-24V60W-0-10V-LPS	11.25 in.	3.75 in.	1.90 in.
DI-DM-MW-24V90W-0-10V-LPL	13.5 in.	4.5 in.	2.37 in.

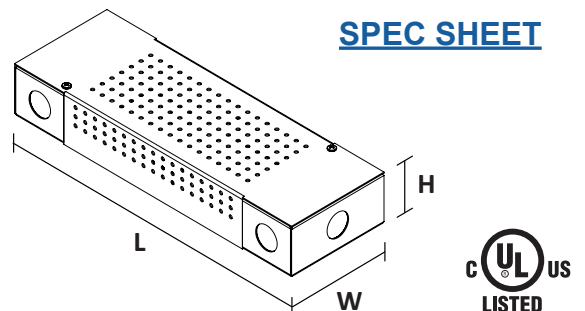

BLAZE™ BASICS 100 Wet Location LED Tape Light

SPECIFICATION SHEET

LED DRIVERS CONT. (Required)

The following Listed LED Drivers are recommended for compatibility and to meet NEC code when installed according to specifications. For additional LED Driver options see Diode LED's product page at: <https://www.diodeled.com/products/led-power-supplies.html>

OMNIDRIVE® 2 ELECTRONIC DIMMABLE LED DRIVER

OMNIDRIVE 2 features a zero minimum load and 100-5% dimming range. Compatible with Forward Phase and Reverse Phase Dimmers. Please see Diode LED's Compatibility List at: <https://www.diodeled.com/custom/download/productFile/filename/DI-OD2-Compatibility%20List.pdf>



SKU	L - LENGTH	W - WIDTH	H - HEIGHT
DI-OD2-24V24W	13.75 in.	3.00 in.	1.60 in.
DI-OD2-24V60W	13.75 in.	3.00 in.	1.60 in.
DI-OD2-24V96W	15.00 in.	3.10 in.	2.40 in.
DI-OD2-24V120W	15.00 in.	3.10 in.	2.40 in.
DI-OD2-24V200W	16.10 in.	3.40 in.	2.40 in.

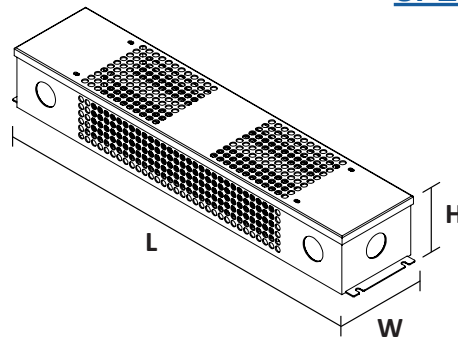

[SPEC SHEET](#)



LUTRON® Hi-lume 1% LED DIMMABLE DRIVER

Hi-lume 1% LED Driver has a minimum load of 5W and dims from 100-1%.

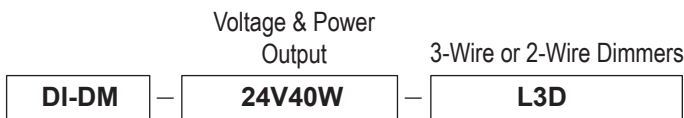

SKU	L - LENGTH	W - WIDTH	H - HEIGHT
DI-DM-24V40W-L3D	4.89 in.	4.00 in.	2.62 in.
DI-DM-24V40W-LTE			

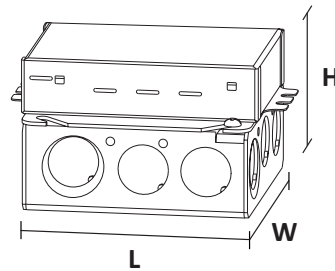

[L3D SPEC SHEET](#)

[LTE SPEC SHEET](#)



LUTRON® Hi-lume Premier 0.1% LED DIMMABLE DRIVER

Hi-Lume Premier 0.1% LED Driver has a minimum load of 5W and dims from 100-0.1%.

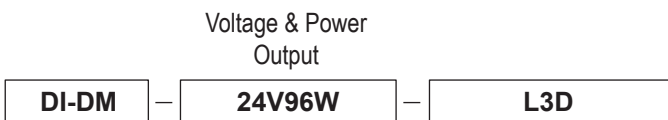

SKU	L - LENGTH	W - WIDTH	H - HEIGHT
DI-DM-24V96W-L3D	5.50 in.	2.20 in.	10.50 in.

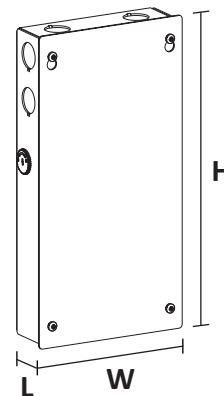

[SPEC SHEET](#)



BLAZE™ BASICS 100 Wet Location LED Tape Light

SPECIFICATION SHEET

LED DRIVERS (Required)

The following Listed LED Drivers are recommended to meet NEC code when installed according to specifications. For additional LED Driver options see Diode LED's product page at: <https://www.diodeled.com/products/led-power-supplies.html>

VLM SERIES CONSTANT VOLTAGE DRIVER

Use Constant Voltage Drivers to power your low voltage tape light. Compatible with Standard 120VAC On/Off Switches, REIGN® 12-24V Low Voltage Dimmers, TOUCHDIAL™ Control System, DMX Decoders, and PWM Controls.

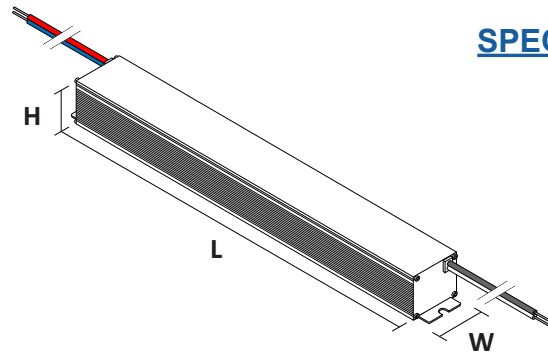
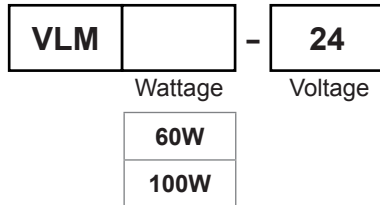

[SPEC SHEET](#)

SKU	L - LENGTH	W - WIDTH	H - HEIGHT
VLM60W-24	5.1 in.	.75 in.	.77 in.
VLM100W-24	5.38 in.	1 in.	.77 in.



BLAZE™ BASICS 100 Wet Location LED Tape Light

ADDITIONAL INFORMATION

- LOW VOLTAGE LED TAPE LIGHT Installation Guide

SAFETY / WARNINGS / DISCLOSURES

1. Install in accordance with national and local electrical code regulations.
2. This product is intended to be installed and serviced by a qualified, licensed electrician.
3. Only install with a Class 2 DC Constant Voltage LED driver.
4. Only use copper wiring. Use wires rated for at least 176°F (80°C) and certified for use with external connection of electrical equipment.
5. Each maximum run requires a dedicated power feed from the driver. Do not extend beyond the recommended maximum run length.
6. Tape light, attached wire leads, and additional extension cables, connectors, etc., are not rated for in-wall installation unless otherwise noted. Tape light and attached wire leads are field-cuttable.
7. Ensure applicable wire is installed between driver, fixture, and any controls in-between. When choosing wire, factor in voltage drop, amperage rating, and type (in-wall rated, wet location rated, etc.). Inadequate wire installation could overheat wires, and cause fire.
8. All plastics are affected by the elements and may shift in color and other properties after product installation, particularly with direct exposure to sun, chlorinated water, and other chemicals.
9. Do not install in environment where excessive heat may exist (ex. close proximity to fireplace, etc.) See Ambient Temperature ratings
10. Do not install indoor LED tape light products in outdoor / wet location environments. Only wet location tape light models are rated for outdoor / wet locations.
11. Do not modify product beyond instructions or warranty will be void.
12. Tape light must be handled with care. Excessive handling, bending, and pressure may damage the product, voiding the warranty.
13. Actual color may vary from what is pictured on this sheet and other print materials due to the limitations of photographic processes.
14. We reserve the right to modify and improve the design of our fixtures without prior notice. We cannot guarantee to match existing installed fixtures for subsequent orders or replacements in regards to product appearance, CCT, or lumen output.

WARRANTY

Limited Warranty

This product has a seven (7) year limited warranty from the date of shipment. This warranty does not include the additional accessories referenced in this specification sheet. Complete warranty details for fixtures and additional accessories are available at www.diodeled.com/limited-warranty/ within the Policies section. For warranty related questions please contact product support.

Consumer's Acknowledgment

Elemental LED, Inc. stands behind its products when they are used properly and according to our specifications. By purchasing our products, the purchaser agrees and acknowledges that lighting design, configuration and installation is a complex process, wherein seemingly minor factors or changes in layout and in-field adjustments can have a significant impact on an entire system. Choosing the correct components is essential. Elemental LED is able to work with the original purchaser to make an appropriate product selection to the extent of the limited information that the customer can provide, but it is virtually impossible for Elemental LED to design a system that foresees every unknown factor. For this reason, this Warranty does not cover problems caused by improper design, configuration or installation issues. Any statement from a Elemental LED employee or agent regarding a customer's bill of goods and/or purchase order is NOT an acknowledgment that the products purchased are designed and configured correctly. The purchase agrees and acknowledges that it is the customer's responsibility to adhere strictly to all information contained in the Product Specification Sheets.

There is often more than one way to design, configure and layout an LED lighting application properly to achieve the same lighting effect. Elemental LED strongly recommends that licensed professionals be used in the design and installation of lighting systems that include Elemental LED products. The specifications include important information that a designer and installer should carefully review and strictly follow. Qualified designers and certified and/or licensed installers, with access to the final installation environment, customer goals, and Elemental LED product specifications can make the requisite decisions appropriate for a successful finished lighting application.

SPECIFICATION SHEET



© 2019 Elemental LED, Inc. All rights reserved.
Specifications are subject to change without notice.

Toll Free: 877.817.6028 | Fax: 415.592.1596 | www.DiodeLED.com | info@DiodeLED.com